



**PUMP-ACTION SHOTGUN
INSTRUCTION MANUAL**



**READ THE INSTRUCTIONS AND
WARNINGS IN THIS MANUAL CAREFULLY
BEFORE USING THIS FIREARM**

GUN SAFETY RULES

Observe these rules of safe gun handling.

1. Always keep the muzzle pointed in a safe direction. Watch the muzzle at all time, never point a gun, accidentally or intentionally, at any person or anything you do not intend to shoot. Identify the target before shooting; do not shoot at sounds.
2. Always treat a gun as if it is loaded - it may be!
3. Keep your finger off the trigger while operating the action and at all other times until you are ready to shoot.
4. Keep the safety "on" or in the "safe" position at all times until you are ready to fire. Do not rely on your gun's safety, the safety on any gun is a mechanical device and is not intended as a substitute for common sense or safe gun handling.
5. Learn how your gun functions and handles. If you do not thoroughly understand the proper use and care of your gun, seek the advice of someone who is knowledgeable
6. Do not alter or modify any part of the firearm.
7. Store guns unloaded, separate from any ammunition, and out of the reach of children.
8. Be sure the barrel is clear of any obstructions before loading. Make it a habit to check the barrel every time before loading.
9. Be sure you have and use the proper ammunition. A 20 gauge shell will enter a 12 gauge chamber far enough so that a 12 gauge shell can be loaded behind it. Also, a 3 inch shell may fit into a 2¾ inch chamber, but the crimp at the mouth of the shell will unfold into the forcing cone. If either of these things occur and you fire the gun, the gun will explode, damaging the gun and possibly causing serious injury or death to you and those around you.
10. Wear protective shooting glasses and adequate ear protection when shooting.
11. Never climb or jump over anything, such as a tree, fence, or ditch, with a loaded gun. Open the barrel, remove the shells and hand the gun to someone else or place it on the ground on the other side of the obstacle before crossing it yourself. Do not lean a gun against a tree or other object; it could fall and possibly discharge.
12. Do not shoot at a hard surface or at water. Bullet and shot can ricochet or bounce off and travel in unpredictable directions with great velocity.
13. Never transport a loaded gun. Do not place a loaded gun into a vehicle. The gun should be unloaded and placed into a case when not in use.
14. Never drink alcoholic beverages before or during shooting.

INTRODUCTION TO CARRERA SPORTING ARMS

For many years, CARRERA has been importing quality shotguns. Combine the old world quality with modern technology, and you have CARRERA Shotguns.

We at CARRERA thank you for the privilege of delivering a product to you that will provide you with years of pleasurable use. Happy shot gunning.

ABOUT YOUR PUMP SHOTGUN

Your CARRERA is manually operated. Once a shell has been fired, the locking lug in the bolt moves down, unlocking the gun. The firearm can then be moved to the rear and forward again, ejecting and loading a new shell.

To open the bolt without firing the gun, depress the action bar lock, located just beside and forward of the trigger. This allows for opening the action without dry firing.

SAFETY SWITCH OR BUTTON

The safety is designed to stop the trigger mechanism.

DON'T RELY ON YOUR GUN'S SAFETY, TREAT EVERY GUN AS IF IT WERE LOADED AND READY TO FIRE. The safety on any gun is a mechanical device, and it is not intended as a substitute for common sense or safe gun handling. Always keep the muzzle pointed in a safe direction.

A- The safety is located behind the trigger, and provides protection against accidental or unintentional discharge under normal usage when properly used.

B- To Engage the safety, push the button so that it protrudes from the right side of the gun and the **RED BAND MARKING CAN NOT BE SEEN**. The safety should always be in the "on" or "safe" position until you intend to fire the gun. (Photo 1)

C- When you are ready to fire the gun, press the safety button to the "off" position so that the safety protrudes from the left side of the gun and the **RED BAND MARKING IS SHOWING**.

DANGER: The gun will fire when the trigger is pulled intentionally or accidentally when the **RED BAND MARKING IS SHOWING**

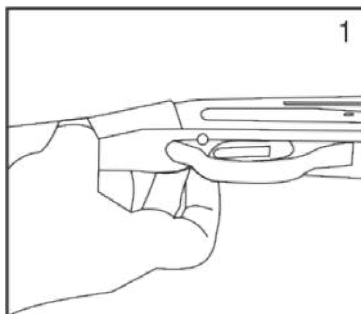

ASSEMBLY

1. Remove the magazine cap.
2. Press upward on the action bar lock. Pull forearm approximately halfway rearward.
3. Hold the barrel ahead of the barrel guide ring (See picture2).
4. Slide the barrel guide ring over the magazine tube. Clean the barrel following the instructions on Page 12.
5. Press upward on the action bar lock.
6. Aling the ejector on the inside of the barrel with the slot in the bolt.
7. Carefully set the barrel into the receiver. DO NOT FORCE IT!
8. Replace the magazine cap. Tighten.

DISASSEMBLY

1. Make sure the gun is unloaded!
2. Point firearm in a safe direction.
3. Point firearm in a safe position.
4. Push up on the action bar lock.
5. Slide forearm forward halfway.
6. Unscrew and remove the magazine cap.
7. Pull the barrel carefully out of the receiver.
8. Push the carrier forward.
9. Depress and hold the action bar lock.
10. Slide the forearm forward and off the magazine tube.

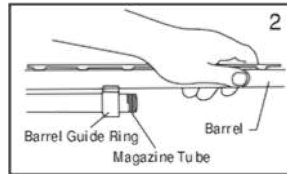

LOADING YOUR SHOTGUN ONE SHELL ONLY

1. Put safety in the "on" position.
2. Point the gun in a safe direction.
3. Push up on the action bar lock.
4. Pull the forearm completely to the rear.
5. Put one shell through the ejection port, making sure it is the correct gauge and length. (See Picture 3)
6. Push the forearm forward and close the action.

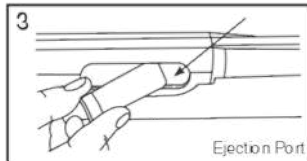

FULLY LOADING YOUR SHOTGUN

1. Put safety in the "on" position.
2. Point the gun in a safe direction.
3. Push up on the action bar lock.
4. Pull the forearm completely to the rear.
5. Put one shell through the ejection port, making sure it is the correct gauge and length. (See picture 3)

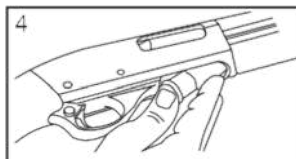

6. Push the forearm forward and close the action.
7. Push a shell upward against the bottom of the carrier. (See picture 4)
8. Push two (2) to four (4) shell, one at a time, fully forward into the magazine tube

INSTALLATION OF MAGAZINE PLUG

Your Shotgun has comes with a magazine plug installed for this purpose.

Installation:

1. Remove the forend screw cap.
2. At the threaded end of the magazine tube (where the forend screw cap fits) you will locate a black snap ring.
3. A Philips head screw driver should be used to remove the snap ring.
CAUTION: The snap ring will be under pressure from the magazine spring. Do not remove the snap ring in a manner where the ring could fly out and strike you or anyone else causing injury, particularly to the eye.
4. Insert plug through the middle of the magazine spring, compress plug and spring, and insert the snap ring so the snap ring end is flush with the end of the tube.
5. Screw forend cap back in place.

THANK YOU

Thank you for purchasing a Carrera shotgun. We are sure this gun will bring you years of hunting and/or shooting pleasure. Your satisfaction is the key to our success. Please let us know if we can be or service and relay any observations about your guns performance or appearance.

Model Number _____

Purchase Date _____

Gauge or Caliber _____

Serial Number _____

Purchase Price _____

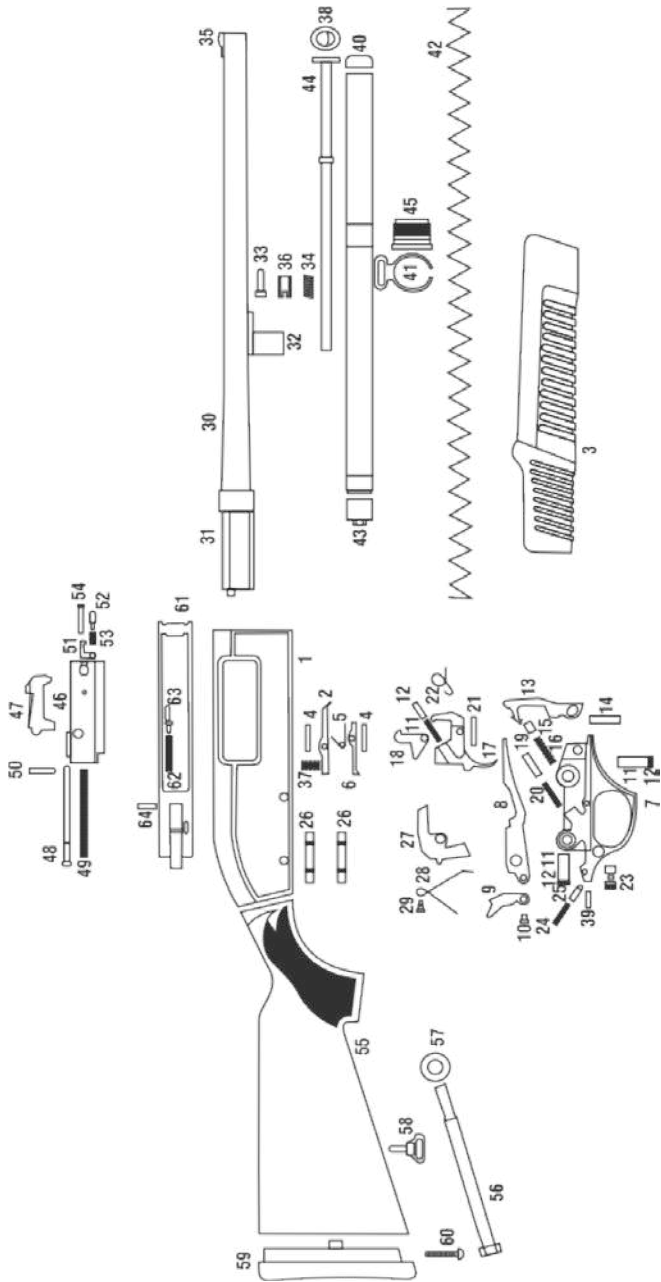

Store Name _____



PART NO	DESCRIPTION	PART NO	DESCRIPTION
1	RECEIVER	33	PUMP RING PIN
2	CARRIER LATCH	34	PUMP RING SPRING
3	FORE-END	35	BEAD
4	CARRIER LATCH PIN	36	PUMP RING SCREW
5	CARTRIDGE HOLDER SPRING	37	METAL HOLDER SPRING
6	CARTRIDGE HOLDER	38	PLUG CAP
7	TRIGGER GROUP	39	SAFETY PIN
8	CARTRIDGE CARRIER	40	MAGAZINE UPPER CAP
9	CARTRIDGE LIFTER	41	SLING SWIVEL
10	CARTRIDGE LIFTER PIN	42	MAGAZINE SPRING
11	INTERNAL SAFETY SPRING	43	CARTRIDGE EJECTOR PLUG
12	INTERNAL SAFETY SPRING CASE	44	PLUG
13	HAMMER	45	MAGAZINE BOLT CAP
14	HAMMER PIN	46	BOLT ACTION
15	HAMMER PIN CAPSULE	47	LOCKING BLOCK
16	HAMMER SPRING	48	FIRING PIN
17	TRIGGER	49	FRING PIN SPRING
18	INTERNAL SAFETY	50	FRING PIN HOLDER
19	INTERNAL SAFETY CAPSULE	51	EXTRACTOR
20	INTERNAL SAFETY SPRING	52	EXTRACTOR PIN
21	TRIGGER PIN	53	EXTRACTOR SPRING
22	TRIGGER SPRING	54	EXTRACTOR SPRING PIN
23	SAFETY	55	GRIP
24	SAFETY SPRING	56	HEAT SHIELD
25	SAFETY CAPSULE	57	HEAT SHIELD SCREW
26	CAPSULE PIN	58	SLING SWIVEL
27	UNLOADING LATCH	59	GRIP KEY
28	UNLOADING LATCH SPRING	60	GRIP SCREW
29	UNLOADING LATCH SPRING SCREW	61	SLIDING BAR
30	BARREL	62	SLIDING BAR SPRING
31	BARREL LUG	63	SLIDING BAR PIN
32	PUMP RING	64	SLIDING BAR RIVETING PIN

USAGE OF CHOKE TUBES

The choke controls how open or tight the pattern of the shot will be. The chart below lists the chokes available (from open to tight), and the cores pending marks that indicate the specific choke.

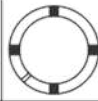
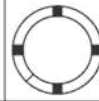
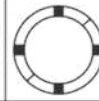
	SKEET	IC	M	IM	F	XF
CHOKE TUBE						
BBLS	CL	****	***	**	*	XF

Never fire your gun or run cleaning tools through a barrel that uses a choke tube without having a choke installed. The threads of the choke tube and the internal threads of the barrel should be cleaned after each use and before installation of the tube. Your CARRERA shotgun uses choke tubes.

To install a tube, insert tube into the top of the barrel and tighten with your fingers. Once the tube is finger tightened, tighten the rest of the way with the appropriate choke tube wrench until the tube is snug. DO NOT over tighten or forcefully tighten with the wrench.

MAINTENANCE AND CLEANING

Caution: Make sure the gun is UNLOADED.

1. Make sure the broad, polished finely fitted mating surface of the breech block and receiver is especially clean and lightly oiled with high quality gun oil. Do not use silicone or lanolin (Do not use WD-40)

2. Run an oil patch through the bore with a cleaning rod starting from the breech end. To prevent leading, use a cleaning solvent and brass brush to clean the bore periodically. Follow this cleaning with one or two clean oil patches. Important: If your gun is equipped with choke tubes, do not use a brass brush to clean the barrels without having a choke tube installed. Barrels that utilize choke tubes must also have the choke tubes removed to clean and oil the threads inside the barrel and the choke tubes themselves. This will protect the threads and prevent dirt build up that can cause tubes to become difficult to remove

Never fire your gun without choke tubes snugly tightened in barrels. Do not over tighten choke tubes. Wipe all exposed metal surface with an oiled cloth before storing. Do not squirt or pour oil into the inside mechanism because it may hamper proper functioning. After extended periods of heavy use, your gun should be taken to a qualified gunsmith to have the action disassembled for professional cleaning and lubrication.

3. Care for your wood stock and forearm the same way you would a piece of furniture with the same finish.

NOT:

NOT:



Üzümlü Mahallesi - Beyşehir - Konya/TURKEY

Tel.: +90 332 524 72 27

www.vezirarms.com